

Applications

Lifting accessory for handling of ferromagnetic plates or round raw or machined loads.

In accordance with EN 13155:2003 standard.

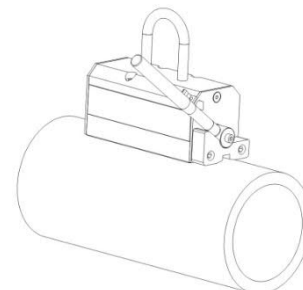
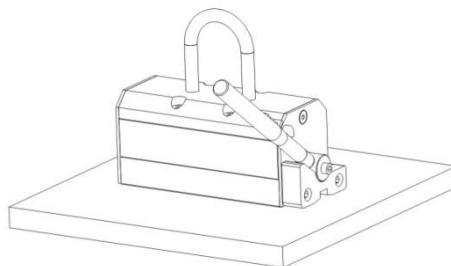
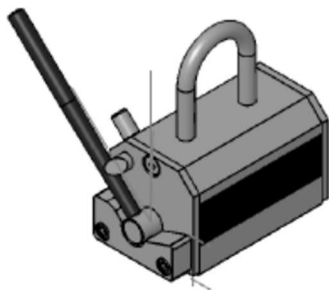

Principle

The magnetic flow generated by the magfor II permanent magnet lifters is, regarding « activated » or « deactivated » position of the rotor, closed on a internal magnetic earth (position « magnet lifter deactivated ») or slanted towards the load (position « magnet lifter activated »), producing one attractive strength between active poles of magnet lifter and this load. This strength depends on loads dimensions (active poles contact surface and thickness of the load) and also on loads magnetic characteristics (iron content).

Qualitative, dimensional & magnetic characteristics of the load have influence on working load limit of a permanent magnet lifter.

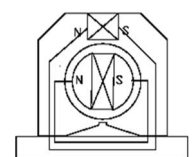

Aimant activé

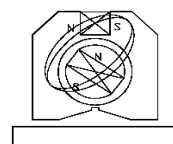

Aimant désactivé

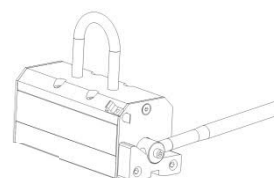
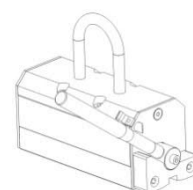

Description

magfor II range is manufactured with high power magnets, which positioning propose a compact solution with an important and reliable force.

The rotor which permits orientation of the magnetic strength on the load is positioned with an ergonomic and robust lever.

Magnet lifters magfor II are fitted out with a safety locking device of the lever which is automatically engaged when lever is in "activated position" in order to avoid any unintentional magnet lifter deactivation. For more safety, magnet lifter deactivation requires use of both hands : one hand to unlock the locking system (3), the other hand to manually accompany the working lever (4).

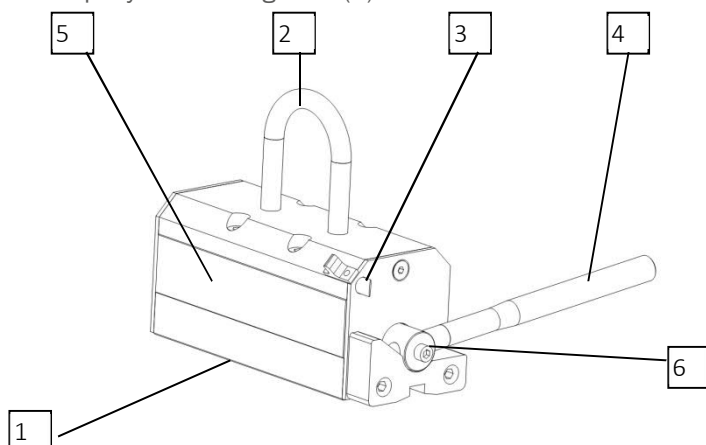

1. Active poles
2. Hooking ring
3. Locking device
4. Working lever
5. Signalling plate
6. Rotor axle

Each magfor II is also fitted out with a reinforced upper ring which offers a big opening for an easy positioning of the lifting device hook.

Capacities* and dimensions¹

IMPORTANT : the working load limit specified on magnet lifter, which corresponds to the above described conditions, must be reduced if these conditions are not respected (see following paragraphs).

magfor II (100 – 300 – 500 – 1000 – 2000 – 3000 - 5000)

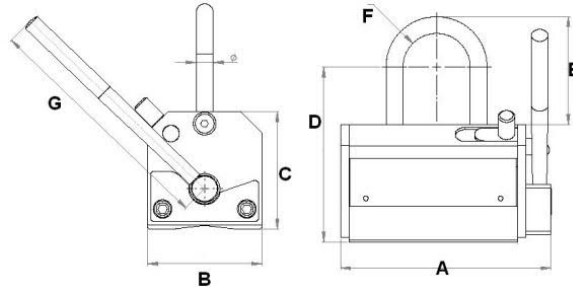

Type	Group code	Temp max(°C)	WLL* On plate	WLL* on round (kg)	Weight	A	B	C	D	E	F	G	Ø
													(mm)
magfor II 100	185438	80	100	50	4	130 +/- 5	74 +/- 5	67 +/- 5	101	63	40	170	10
magfor II 100 HO	185508								/	/	/		/
magfor II 180 TP	185528	80	180	/					144				
magfor II 200 HT	185518	250	200	100	9.5	200 +/- 10	80 +/- 10	88 +/- 5	132	82	50	193	12
magfor II 300	185448	80	300	125									
magfor II 300 HO	185538								/	/	/		/
magfor II 300 TP	185558	80	300	/					156				
magfor II 400 HT	185548	250	400	200	18	250 +/- 15	106 +/- 10	98 +/- 10	144	87	50	193	16
magfor II 500	185458	80	500	215									
magfor II 500 HO	185568								/	/	/		/
magfor II 800 HT	185578	250	800	400					180	120	80	320	20
magfor II 1000	185468	80	1000	450	41.5	348 +/- 25	142 +/- 10	120 +/- 15					
magfor II 1000 HO	185588								/	/	/		/
magfor II 2000	185478	80	2000	800	113	445 +/- 35	208 +/- 10	171 +/- 20	236	138	95	408	25
magfor II 3000	192138	80	3000	1200	190	501 +/- 35	254 +/- 10	195 +/- 20	295	190	100	450	40
magfor II 5000	192148	80	5000	2400	400	575 +/- 35	350 +/- 10	230 +/- 20	380	200	100	600	50

* WLL: Working Load Limit

* Specified capacities concern a steel with low carbon content (like S235 steel) with a surface roughness ≤ 0,1 mm (smooth and clean manufactured surface) and for load dimensions which are within the parameters given on the « practical tables for capacity reduction ».

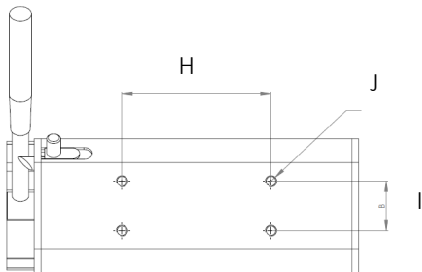

Type	Group code	H	I	J	
					(mm)
magfor II 100 HO	185508	54	28	2x M6 prof. 12/15	
magfor II 300 HO	185538	85	36	4x M6 prof. 12/15	
magfor II 500 HO	185568	108	36	4x M8 prof. 16/19	
magfor II 1000 HO	185588	120	50	4x M10 prof. 20/24	

We can manufacture special poles adapted to specific load cases, please consult us.

¹ The dimensions given are approximate and subject to change without notice

Influential factors on lifting capacity

Kind of load

Kind of steel **	%	CMU* (kg)							
		100	300	500	1000	2000	3000	5000	
Low carbon content steel (E24-2, S235)	100 %	100	300	500	1000	2000	3000	5000	
St 52 (A50-2)	96 %	96	288	480	960	1920	2880	4800	
Stainless steel 430F	50 %	50	150	250	500	1000	1500	2500	
Cast-iron	45 %	45	135	225	450	900	1350	2250	
Nickel	10 %	10	30	50	100	200	300	500	
Stainless steel 304	0 %	0	0	0	0	0	0	0	

*WLL: Working Load Limit

** non exhaustive list

*** % regarding maximum working load limit of considered magnet lifter in case of a steel with low carbon content (like S235 steel) with a surface roughness $\leq 0,1$ mm (smooth and clean manufactured surface) and for loads dimensions which within the parameters given on the « practical tables for capacity reduction »

Air-gap

Corresponds to the space between the magnet lifter active poles and the load due to surface roughness, the oxidation, paper or painting on the load, flashings, etc.

A rusted hot laminated plate presents an air-gap from 0.1 to 0.3 mm. Surface roughness on a piece in wrought iron can reach 0.5 mm.

Permanent magnet lifter capacity is reduced when the air-gap increases.

Dimensions and shape of the load

Thickness and contact surface: a load too thin or a contact which doesn't cover all the active poles surface, doesn't allow a good closing of the magnetic circuit and limit strength of the flow on the load.

IMPORTANT: presence of holes with large dimensions also limits the magnet lifter capacity.

Length: bending of the load due to its important length produces an air-gap and consequently reduces the lifting capacity.

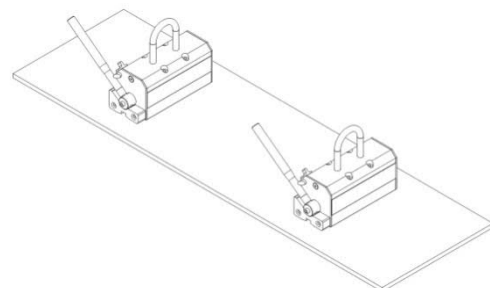
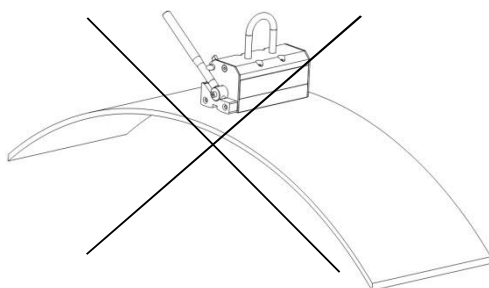

Load horizontality

To achieve the maximum capacity of a magnet lifter, magnet forces must be perpendicular to the active poles surface. That is why it is necessary to find out, with a good positioning of the magnet lifter, the best horizontality of the load during lifting.

Practical tables for capacity reduction:

Determination of permanent magnet lifters magfor II capacity in case of S235 steel plates.

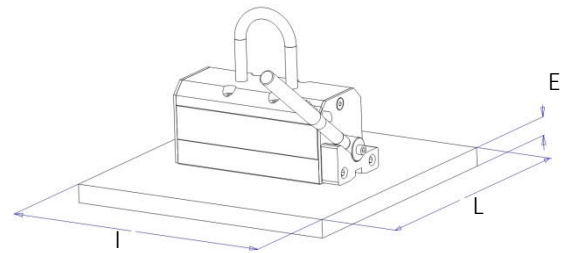

	E (mm)	L min x l min (mm)	Ground, clean & smooth surface Air gap < 0,1 mm			Hot rolled, rusty surface Air gap 0,1 to 0,3 mm CMU* (kg)			Irregular and rough surface Air gap 0,3 to 0,5 mm		
			Std and HO	TP	HT	Std and HO	TP	HT	Std and HO	TP	HT
magfor II 100 magfor II 100 HO	≥ 15	200	100			60			50		
	≥ 10		80			45			30		
	≥ 6	x	40			30			25		
	≥ 4	200	28			20			15		
magfor II 180 TP magfor II 200 HT magfor II 300 magfor II 300 HO	≥ 25	300	300	180	200	210	135	140	110	70	70
	≥ 15		240			160			180		
	≥ 10	x	160		105	130		85	85		55
	≥ 6	300	95		60	80		50	60		40
magfor II 300 TP magfor II 400 HT magfor II 500 magfor II 500 HO	≥ 4	400	60	300	40	50	225	300	40	150	25
	≥ 30		500			400			380		
	≥ 20	x	425		340	320		255	220		175
	≥ 15	400	400		320	300		240	205		160
magfor II 800 HT magfor II 1000 magfor II 1000 HO	≥ 10	500	265		210	220		175	165		130
	≥ 8		200			160			160		
	≥ 6	x	130		100	100		80	90		70
	≥ 50	500	1 000		800	845		675	650		520
magfor II 2000	≥ 30	800	860			730			580		450
	≥ 25		830			660			705		
	≥ 20	x	700		560	600		480	450		360
	≥ 15	500	500		400	445		355	330		260
magfor II 3000	≥ 10	900	265		210	240		190	180		140
	≥ 60		2 000						1 600		
	≥ 40	x	1 750			1 410			1 140		
	≥ 30	600	1 500			1 210			1 010		
magfor II 5000	≥ 25	600	1 230			1 055			890		
	≥ 20		1 000			800			680		
	≥ 15	x	690			520			470		
	≥ 80	900	3 000			2 550			1 900		
magfor II 5000	≥ 60	1000	2 550			2 150			1 600		
	≥ 40		x			2 200					
	≥ 30	600	1 650			1 400			1 020		
	≥ 20	x	900			765			550		
magfor II 5000	≥ 100	1000	5 000			4 250			3 250		
	≥ 80		x			4 250					
	≥ 60	x	3 250			2 750			2 100		
	≥ 40	600	2 180			1 850			1 400		
≥ 30	x	1 500			1 270			975			

* WLL: Working Load Limit

This value will be reduced if load characteristics (steel with low carbon content) and use instructions of magnet (load horizontality, active poles condition, etc.) are not respected – see page 3.

Practical tables for capacity reduction:

Determination of permanent magnet lifters magfor II capacity in case of S235 steel round surface.

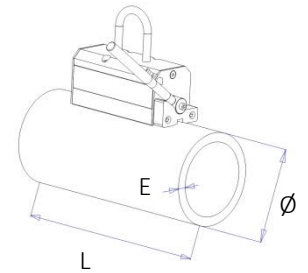

Please note, magfor II TP for thin plates are not designed for handling rounds.

	∅ D min (mm)	∅ D max (mm)	E min (mm)	Air gap < 0,1 mm		Air gap 0,1 to 0,3 mm		Air gap 0,3 to 0,5 mm	
				WLL* (kg)	L max (mm)	WLL* (kg)	L max (mm)	WLL* (kg)	L max (mm)
magfor II 100	40	100	15	50	2 500	40	1 700	30	1 500
magfor II 100 HO									
magfor II 200 HT	40	160	25	80	3 500	65	3 000	50	2 500
magfor II 300	40	160	25	125	3 500	100	3 000	80	2 500
magfor II 300 HO									
magfor II 400 HT	40	220	30	170	4 000	140	3 500	110	3 000
magfor II 500	40	220	30	215	4 000	180	3 500	140	3 000
magfor II 500 HO									
magfor II 800 HT	60	350	40	360	4 500	300	4 000	240	3 500
magfor II 1000	60	350	40	450	4 500	380	4 000	300	3 500
magfor II 1000 HO									
magfor II 2000	80	400	60	800	5 000	650	4 500	550	4 000
magfor II 3000	160	400	80	1 200	5 000	1 000	4 500	750	4 000
magfor II 5000	160	400	100	2 400	5 000	2 000	4 500	1 500	4 000

* WLL: Working Load Limit

* This value will be reduced if load characteristics (steel with low carbon content) and use instructions of magnet (load horizontality, active poles condition, etc.) are not respected – see page 3.

Important instructions

- Never use for personnel lifting.
- Strictly forbidden to either be under or walk under the load.
- Never activate the magnet lifter when thickness of the load doesn't respect the minimum values specified on the « practical tables for capacity reduction » or on the signalling plate.
- Never release the lever freely, always maintain a grip on the lever
- Never remove the lever in active position
- Ensure the load is in a stable position before deactivating the magnet lifter
- Never lift more than one plate at a time. Take a particular care in case of thin plates lifting.
- Never leave a suspended load unsupervised
- Temperature of the load or/ and atmosphere must be between -20 and +80 °C. (-20 to +250 °C for magfor II HT)
- Never lift dangerous, explosive or radioactive loads.
- Never lift loads on which non-attached charges on top.
- Never exceed weights or min/ max dimensions specified in « technical specifications ».
- Never use a magnet lifter in case of aggressive, chemical, acid or saline atmosphere.
- Never lift a load by installing the magnet lifter on the narrowest or smallest side.
- Always install the magnet lifter with its longitudinal side on transversal direction of the load

